

Section 1

General Description

The **M-PROX2** (CV-602) is a 2 door access control system. It has 2 inputs for HID/AWID proximity readers, 2 Form C relay outputs for connection to electrified or magnetic locks for door access control, and can accept up to 2,000 user codes. System features include:

- 12/24 V AC/DC operation
- 2,000 user codes
- 2 Wiegand inputs
- Request-to Exit
- 2 Form C relay outputs, 5A @ 30V DC
- Timed relay output
- Individual/batch card enrollment
- Individual/batch card deletion
- Group assignment
- 26, 34 and 37 bit wiegand compatible
- Operating modes: full, hard or timed anti passback
- Password protection
- USB port for PC interface
- Audit trail
- Scheduling – daily, weekly, holidays

The **M-PROX2** may also be programmed locally via the 4 button and 4 digit LED display. Features available for local programming are:

- Programming new codes into memory
- Deleting single codes from memory
- Selecting bi-stable or timed operation mode independently for each relay
- Setting the relay activation time
- Setting the internal clock

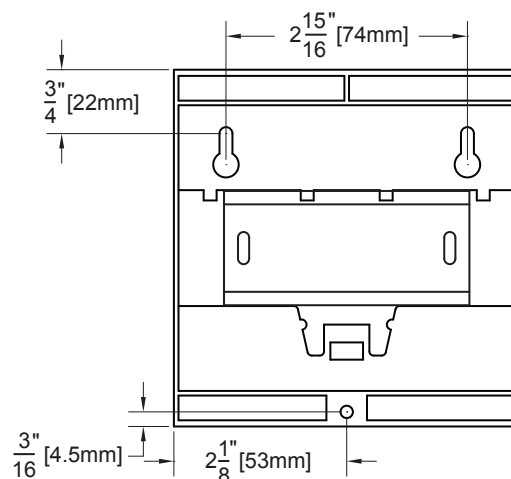
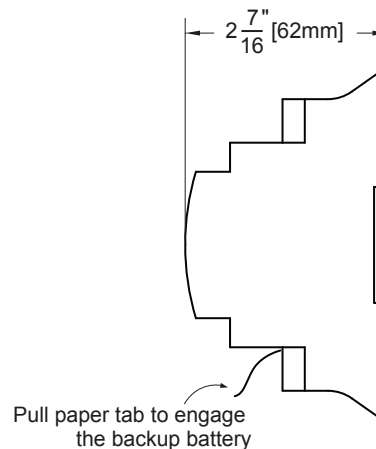
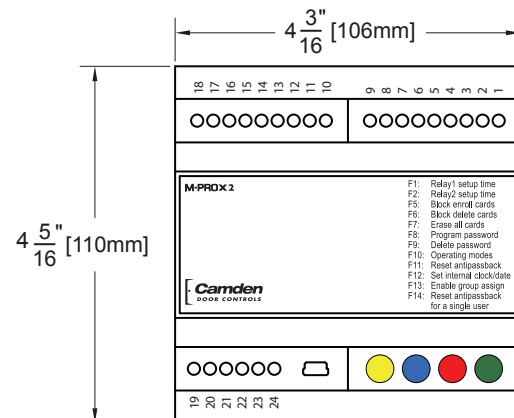

Section 2

Installation

The **M-PROX2** is housed in a plastic enclosure suitable for indoor installations. It is compatible with standard 35 x 7.5 mm DIN rails or the provided mounting holes may be used.

Wiring

Connect your 12/24V AC/DC positive output to the 12-24 V input. Connect your 12/24V AC/DC common output to the ground input. Connect the proximity readers as shown:

1	Port 2: relay contact N.C.	13	Port 1: enable
2	Port 2: relay common	14	Port 1: activate
3	Port 2: relay contact N.O.	15	GROUND
4	Port 2: enable	16	Port 1: (DATA1)
5	Port 2: activate	17	Port 1: (DATA0)
6	GROUND	18	Port 1: power reader supply (9Vdc)
7	Port 2: (DATA1)	19	Antenna
8	Port 2: (DATA0)	20	Antenna braid
9	Port 2: power for reader (9Vdc)	21	Serial line (RS485)
10	Port 1: relay contact N.C.	22	Serial line (RS485)
11	Port 1: relay common	23	Power supply, + 12-24Vac/dc
12	Port 1: relay contact N.O.	24	Power supply, - 12-24Vac/dc

12 – 24 V and Ground

Power input terminals allow for 12 to 24V AC/DC.

Data Link

Factory Use Only

Antenna and Antenna Shield

Factory Use Only.

9V DC Out

Output power for the wiegand reader.

DATA 0 and DATA 1

These are the wiegand data inputs. Connect the wiegand reader/keypad data lines to these inputs.

Activate (Request to Exit)

Activate may be connected to push buttons mounted on the door or to REX Sensors mounted near the door. The push buttons or REX Sensor normally open dry outputs are connected across the Activate and Ground. A contact closure across Activate and Ground will cause the **M-PROX2** to grant access through the appropriate door.

Enable

The Enable input is used to enable the output relay. A connection to Ground will enable the output relay. The **M-PROX2** is shipped with a jumper installed, enabling the output relay at all times. This jumper can be replaced with a Dry contact across the Enable and Ground pins from an external control device, providing hardware controlled access.

Relay Outputs

These are the door control relays. Connect these relay outputs to the magnetic lock or electric strike as required.

NOTE: The **M-PROX2** does not provide power on these outputs for the door locking devices. A separate power supply must be used to provide power to the locking devices. Please refer to Drawing:

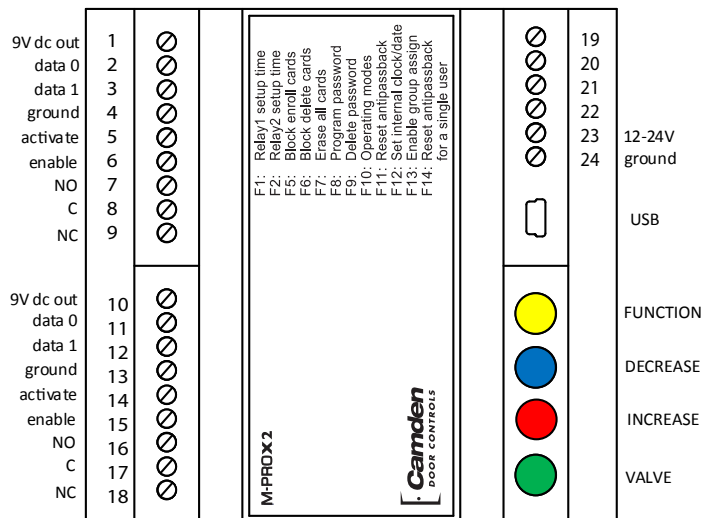

MProx2 Pinout Diagram

NOTES:

1. Diagram shows a CM-120Wv2 Keypad with a CV-7500 AWID proximity reader. (2) CV-7500's or (2) CM-120 keypads could be used.
2. The CM-120 keypad must be in Wiegand Mode. Refer to Appendix A for programming instructions.

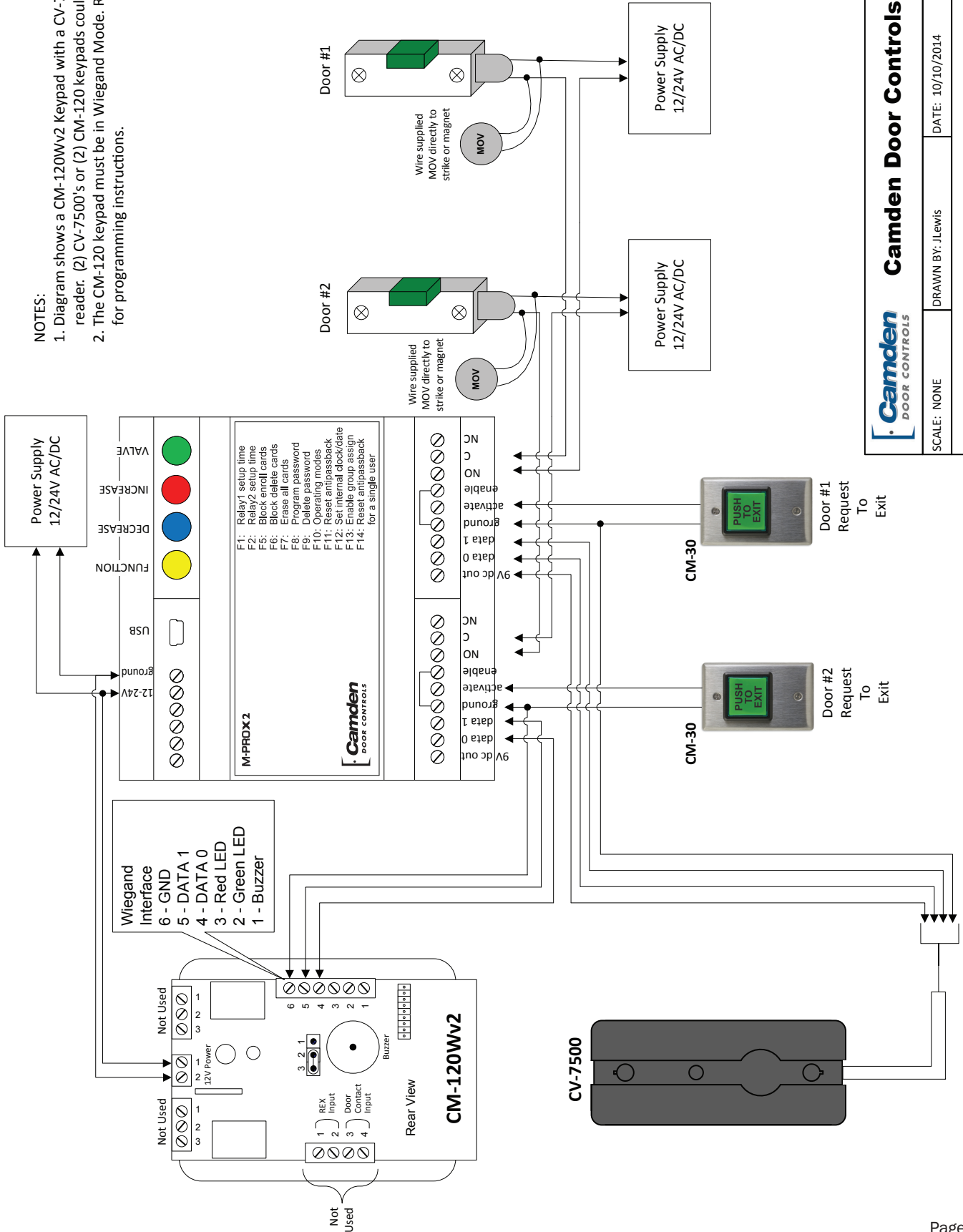

5502 Timberlea Blvd
Mississauga, Ontario
L4W 2T7

Camden Door Controls

SCALE: NONE

DRAWN BY: J.Lewis

DATE: 10/10/2014

REVISED: 10/10/2014

MProx2 Wiring Diagram

DRAWING No:

FILENAME: MProx2 Diagram 1.vsd

Section 3

Programming

Local setup and Configuration

The **M-PROX2** is easily programmed locally via 4 buttons and a 4 digit display. User codes may be enrolled individually or in groups. The buttons are:

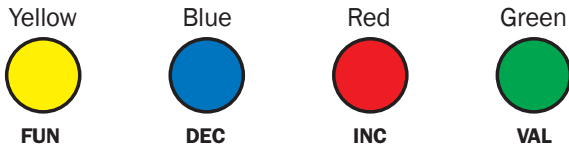

FUN – [Function Button]

Allows you to select the function to program.

DEC – [Decrease Button]

Moves down the list of available options.

INC – [Increase Button]

Moves up the list of available options.

VAL – [Value Button]

Changes the value of the selected function.

Also used as a confirmation button.

Enter Programming Mode

Press the Red and Blue together and release.

Functions

There are 12 available functions when programming the **M-PROX2**. They are:

F1 – Relay 1 Setup time – Set the ON time for Relay 1

Press the Red and Blue together and release to enter programming mode

Press Yellow. Use the Red and Blue to select F01.

Press Green to confirm and exit.

Press Red or Blue to increase or decrease the Relay ON time.

Press Green to confirm and exit.

F2 – Relay 2 Setup Time – Set the ON time for Relay 2

Press the Red and Blue together and release to enter programming mode

Press Yellow. Use the Red and Blue to select F02.

Press Green to confirm and exit.

Press Red or Blue to increase or decrease the Relay ON time.

Press Green to confirm and exit.

F3 – Reserved

F4 - Reserved

F5 – Block Enroll Cards – Enroll cards in batches/groups

Access programming mode by pressing keys Red+Blue.

Press the Yellow key to access the function selection menu.

Select function F5 by pressing keys Red and Blue

Confirm by pressing the Green key. The first memory slot location to be programmed will now appear, default value being 0001. Only the first decimal point to the left will appear indicating that the initial location is being selected.

Select memory location by pressing keys Red and Blue, and confirm by pressing the Green key.

The memory location to be programmed will now appear. The value shown is the one which has been previously selected as the initial location so that only a value greater than this can be selected by pressing keys Red and Blue.

The last decimal point to the right will now appear indicating that the final location is being selected.

After selection of the final memory location, confirm by pressing the Green key.

If group association is enabled, the display will show GR00.

Select the group by pressing either Red and Blue. If GR00 is selected, then no group will be assigned.

Press the VAL (Green) button to confirm your settings. The

M-PROX2 is now ready to accept the first code to be enrolled.

Four decimal points are displayed. Present your first card/keytag to the reader. Once the code has been received, all subsequent memory locations up to the final one are programmed with codes calculated from the starting code plus one. During the programming operation the four decimal points will blink. If a code to be programmed already exists, then the operation is aborted and ERR is displayed.

Example: initial location = 120, final location = 127, received code = 112233

Location	Code
120	112233
121	112234
122	112235
123	112236
124	112237
125	112238
126	112239
127	112240

Once all locations having been filled with the codes, the system will return to the function menu.

F6 – Block Delete Cards – Delete cards in batches/groups

Access programming mode by pressing keys Red+Blue.

Press the Yellow key to access the function selection menu.

Select function F6 by pressing keys Red and Blue.

Confirm by pressing the Green key. Request of the first location to be deleted (that is, the default value 0001) will now appear. Only the first decimal point to the left will appear indicating that the initial location is being selected.

Select location by pressing keys Red and Blue, and confirm by pressing the Green key.

Request of final location to be deleted will now appear. The value shown is the one which has been previously selected as the initial location so that only a value greater than this can be selected by pressing keys Red and Blue. The last decimal point to the right will now appear indicating that the final location is being selected.

After having selected the final location, confirm by pressing the Green key; the letter -C- will now appear on the left-hand side of the display.

Press the Green key again to confirm. The **M-PROX2** will now automatically delete all the codes stored in the set of programmed locations.

Press keys Red and Blue at the same time to exit programming

Upon deletion being completed, system will return to the function selection menu.

F7 – Erase all Cards – Delete all cards from the system

Deletion of all codes avoids having to scroll all locations and having to delete one code at a time in case of memory having to be fully cleared.

Access programming mode by pressing keys Red+Blue.

Press the Yellow key to access the function selection menu.

Select function F7 by pressing keys Red and Blue.

Confirm by pressing the Green key. The letter C will appear on the left side of the display.

Confirm again by pressing the Green key. The **M-PROX2** will fully delete the code area only. All other stored parameters (schedules, Holidays, etc.) will remain unaltered.

Press keys Red and Blue at the same time to exit programming.

Upon deletion being completed, system will return to the function selection menu.

F8 – Program Password

Access programming mode by pressing keys Red + Blue.

Press the Yellow key to access the function selection menu.

Select function F8 by pressing keys Red and Blue and confirm by pressing the Green key.

The letter P will appear on the left side of the display. Digit a sequence of six keys within 10 seconds.

Note: Store your password in a secure place for retrieval later. If your password is lost, a full reset will have to be performed and all data will be lost.

Upon the full sequence of six keys having been completed, the function selection menu will reappear on the display.

Press keys Red and Blue at the same time to exit programming

Failure to complete sequence within 10 seconds will abort password entry. This also avoids entry of incorrect passwords in case of any doubts as to the sequence to be entered or erroneous pressing of any key.

The password is stored in EEPROM and is requested whenever Red+Blue are pressed to access programming mode starting from the stand-by status (displays being off). In this case:

The letter P appears on the left side of the display. Digit the sequence of six keys corresponding to the password. Upon the 6-key sequence being completed, programming mode is accessed. If sequence is erroneous, the displays will go off.

Upon programming mode being accessed, any resident password may be deleted or replaced with a new one repeating the operation.

Note: To remove a password which has been forgotten, contact system supplier. This requires a full system reset.

F9 – Delete Password – Delete the password

Press Red+Blue to access programming mode: the password will be requested.

Key in the password.

Press the Yellow key to access the function selection menu.

Select the password entry function F9 by pressing keys Red and Blue and confirm by pressing key Green: the password will be requested.

Key in the password.

Password is deleted and will not be requested upon any subsequent accessing of programming mode.

Press keys Red and Blue at the same time to exit programming

F10 – Operating Modes – There are 3 operating modes.

1. Full –All cards programmed will activate both Relay 1 and Relay 2 when presented to the Prox reader. programming mode
2. Pass –Hard anti-passback. Once one of the two relays is activated, it will not reactivate until the other relay has been activated.
3. APt – Timed anti-passback. Once one of the relays has been activated, it can't be reactivated until the preset timer has run out.

Press keys Red and Blue at the same time
 Press key Yellow to access the select functions menu
 Using keys Red and Blue select function F10
 Confirm the selection with Green: the display shows the current value of the mode.
 Using keys Red and Blue select mode Full, Half or Pass.
 Confirm with key Green: the display returns to selecting functions and the new mode is active.
 Press keys Red and Blue at the same time to exit programming.

F11 – Reset Antipassback

Access programming mode by pressing keys Red+Blue.
 Press the Yellow key to access the function selection menu.
 Select function F11 by pressing keys Red and Blue.
 Confirm by pressing the Green key. The letter O will appear on the left side of the display.
 Confirm again by pressing the Green key. The state of all the users will be set to idle (the first activation is enabled on every direction).
 Press keys Red and Blue at the same time to exit programming.

F12 – Set Internal Clock/Date – Set the time and date for the audit log

Access programming mode by pressing keys Red+Blue.
 Press the Yellow key to access the function selection menu.
 Select function F12 by pressing keys Red and Blue.
 Confirm by pressing the Green key. The letter H will appear followed by the actual hours.
 Select the value using the Red key.
 Confirm by pressing the Green key. The letter M will appear followed by the actual minutes.
 Select the value using the Red key.
 Confirm by pressing the Green key. The letter Mo will appear followed by the actual Month.
 Select the value using the Red key.
 Confirm by pressing the Green key. The letter D will appear followed by the actual Day.
 Select the value using the Red key.
 Confirm by pressing the Green key. The actual day of the week will appear.
 Select the value using the Red key.
 Confirm by pressing the Green key. The letter Y will appear followed by the actual Year.

Select the value using the Red key.
 Confirm by pressing the Green key. DST followed by Y (Yes) or N (No) will appear.
 Select the value using the Red key.
 Confirm with key Green: the display returns to selecting functions and the clock will be set.
 Press keys Red and Blue at the same time to exit programming.

F13 – Enable Group Assign – When enrolling cards in batches, you have the option to assign groups to the batches. If this function is disabled, you cannot assign groups to batches.

Simultaneously press keys Red and Blue.

Press key Yellow to access the function selection menu.
 Select function F13 by pressing keys Red and Blue.
 Confirm selection by pressing the Green key; current parameter value will appear on the display.
 Select the desired value by pressing keys Red and Blue. (GRPY to enable and GRPn to disable)
 Confirm by pressing key Green and the value will be stored.
 Press keys Red and Blue to exit from programming mode.

F14 – Reset Antipassback for a single user –

Press keys Red and Blue at the same time.
 Press key Yellow to access the select functions menu.
 Using keys Red and Blue select function F14.
 Confirm the selection with Green: the display shows the current value location of the first memorized code.
 Use the Red and Blue buttons to select the location to be reset.
 Once the location has been chosen, confirm with Green: the display shows "rAPB".
 Confirm with Green: the display shows the location again and the user is set in Idle state (see previous point). Exit by pressing Yellow.
 Press Red and Blue keys at the same time to exit programming.

Software Manager Programming

The **M-PROX2** Software Manager provides advanced programming functionality. You can set up multiple installation profiles to be saved on your PC.

Installation

1. Windows 7 (32 or 64 bit)
 Insert the CD/USB memory stick into your computer.

Open the folder on your computer containing the **M-PROX2** software. Run Setup.bat.

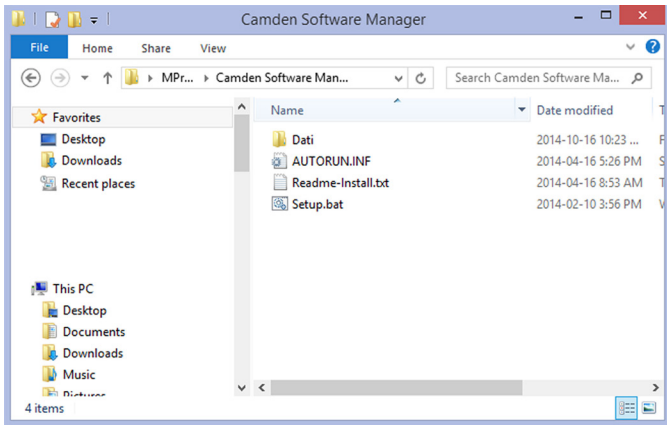

The system will automatically detect your operating system and start installing.

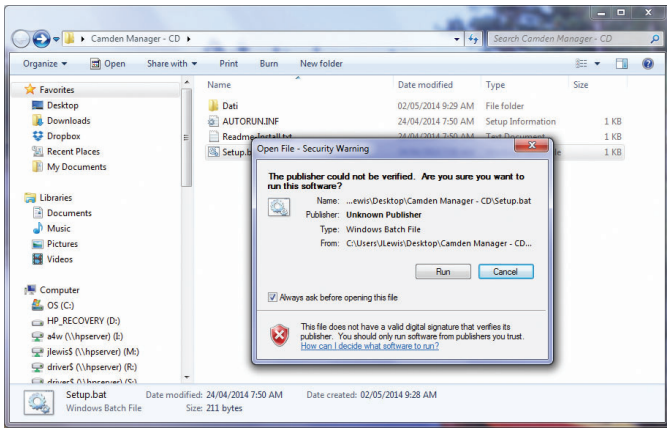

When prompted with a Security Warning, select Run. The software will unpack the installation files start the setup program.

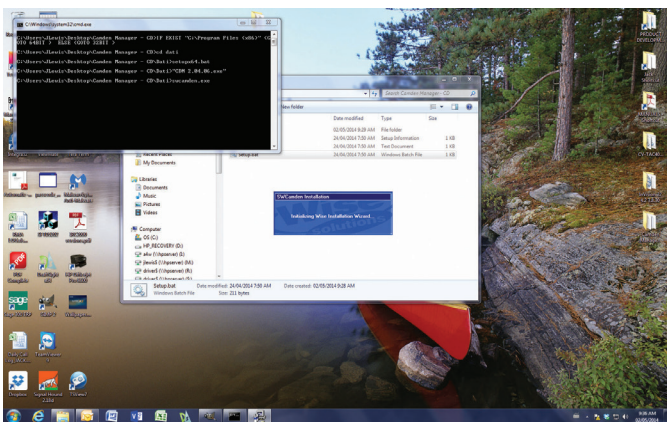

Select your language.

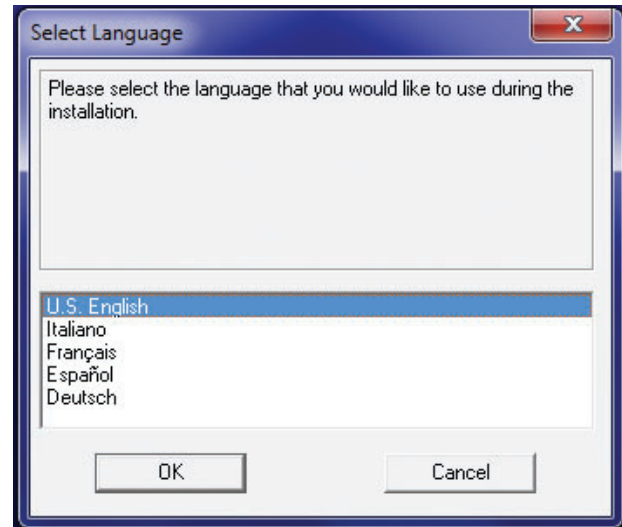

Select Next.

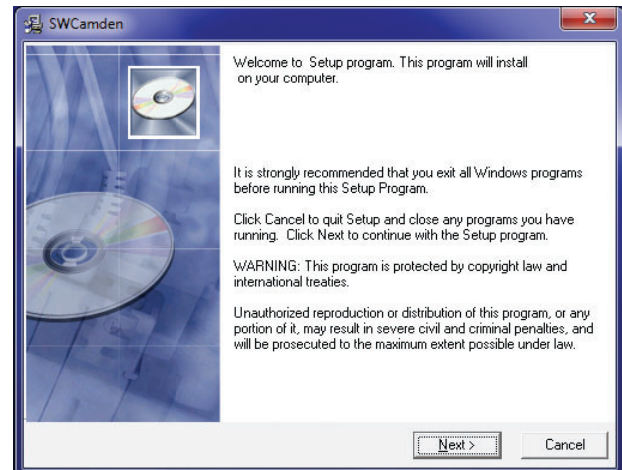

Select the installation destination or accept the default and press Next.

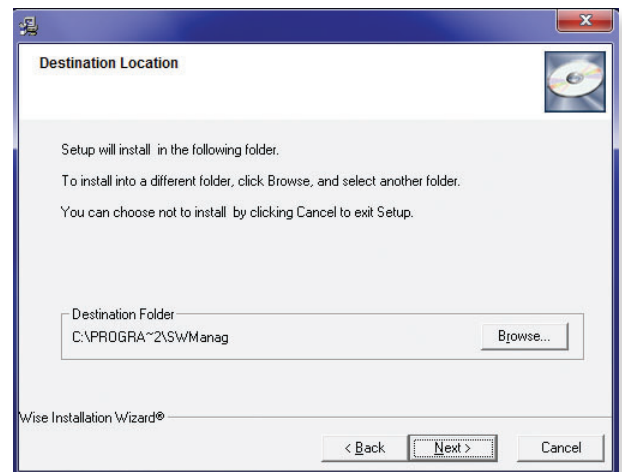

Select a Program Manager Group or accept the default. Press Next.

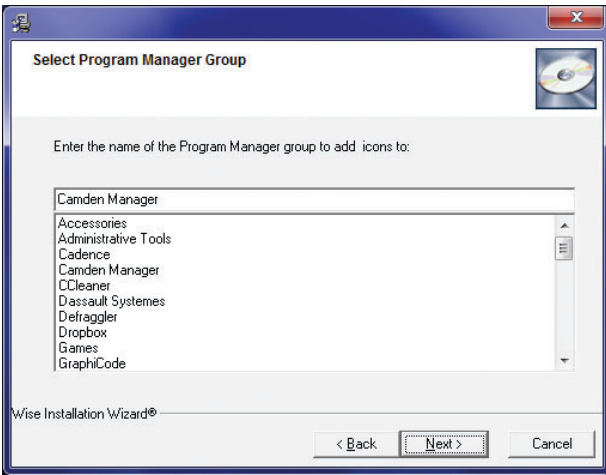

Select Next to start installing the software.

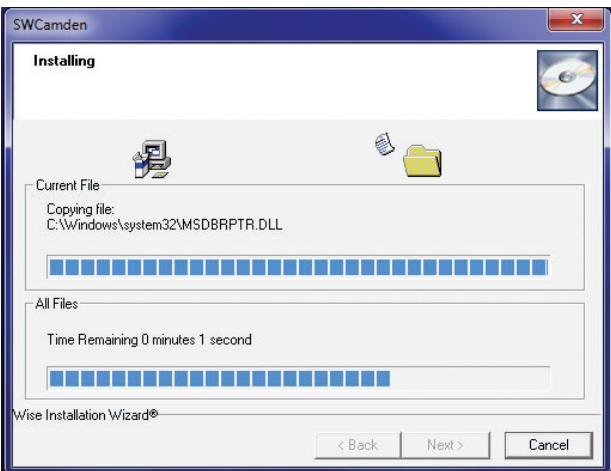

Select Finish.

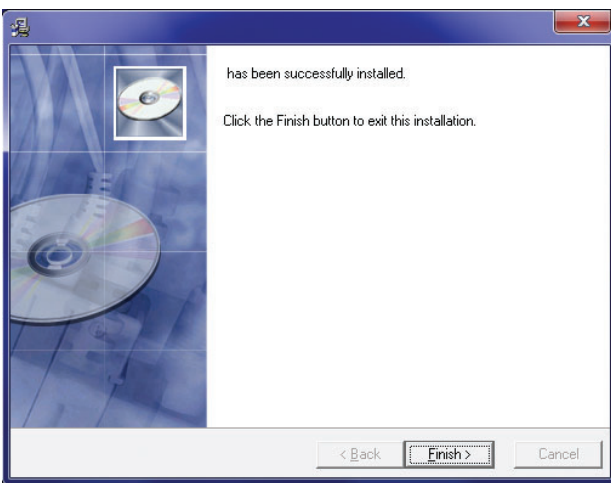

The final step is a small utility that runs to make final configuration changes to support the software. Please allow this to run. The screen will disappear when it has completed.

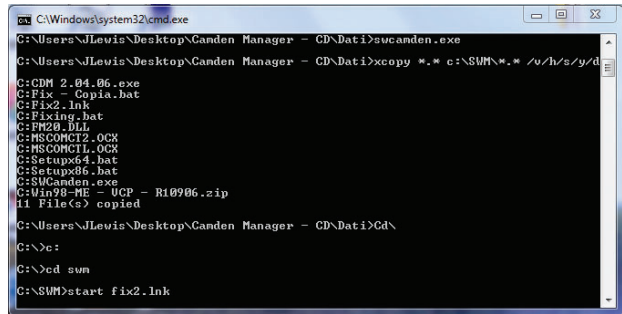

Section 4

Operation

1. Starting Camden Software Manager

a) Working Offline

The Camden Software Manager can be used without an **M-PROX2** connected. You can create installations and save them to be uploaded to an **M-PROX2** when ready. When there is no **M-PROX2** connected via USB, the software will only display 3 menu items. File, Hardware and Utilities.

i. File

The File Menu is used to create Installations, setup schedules and profiles. Other functions such as Importing and Exporting databases, creating a Maintenance schedule are available.

a. Creating an Installation

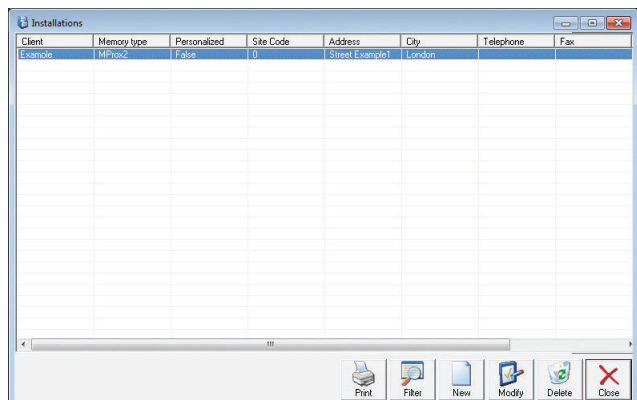

Multiple installations may be created and then uploaded to the different **M-PROX2** systems when online. To create an installation, open the Files Menu and select Installations. From the icons on the bottom of the window, select New.

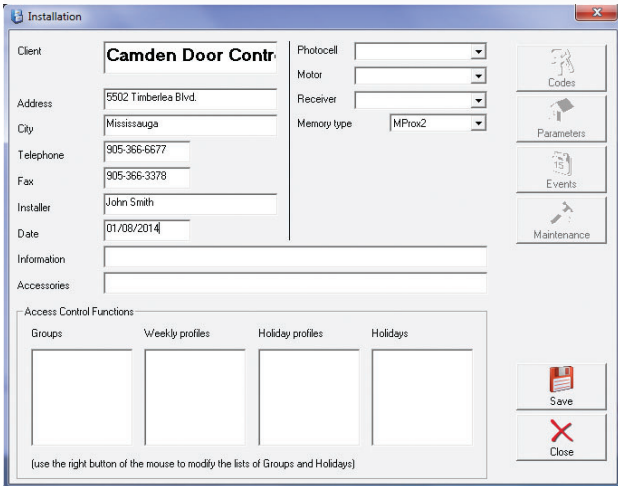

In the Installations dialog, enter all pertinent information about the installation. Client details, creation date and other information required. From the Memory Type pull down menu, select **M-PROX2**.

Right-Click in the Groups, Weekly profiles, Holiday profiles and Holidays windows to Add/Delete Groups, profiles and Holidays.



Codes: Press this button to add/remove or view codes.

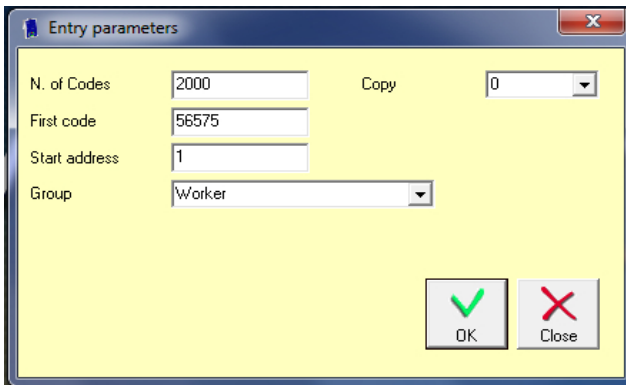

Adding Codes to an Installation

Select the New Icon.

Enter the Number of Codes. Codes may be entered 1 at a time or in sequential batches.

Enter the First Code

Enter the Start address for the first code.

Assign a Group.

Type a description

Copy – N/A



Parameters Press this button to set advanced features of the **M-PROX2**. Select Personalized to add a site code. Up to 4 additional site codes may be added if required.

Memory

Personalized

Select this option and enter a site code to force the **M-PROX2** to only function with the assigned Site Code. Additional site codes are entered in the Extra Site options. Using the Extra Site Start and Extra Site Stop, a range of site code may be entered. Alternatively, Individual site codes may be added using the Extra Site 3 and Extra Site 4 settings.

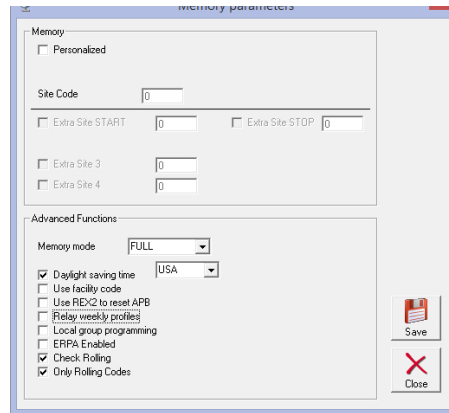

Advanced Functions

Memory Mode

Full – Anti-pass back is disabled. All users have access to Relay1 and/or Relay2.

APB – Anti-pass back is enabled. Relay1 is an Entry relay and Relay2 is the Exit relay. Once Relay 1 has been activated, it cannot be reactivated until Relay 2 has been activated.

APT – Timed Anti-pass back. After the entry of a user, he cannot re-enter for X minutes unless, in the meantime, he exits. The inhibit time field is displayed to set the inhibition period in minutes.

Daylight Savings Time

Enable Daylight Savings Time (DST). Select either North American (USA) or European (EUR) standard.

Use Facility Code

Select this option to enable the MProx2 to look for a facility code when a card is swiped.

Use REX2 to reset APB

When enabled, a contact closure across pins 5 (Activate) & 6 (Ground) will reset the status of the Anti-Pass Back feature.

Relay Weekly Profiles

Relay weekly profiles are used to set up schedules for when Relay 1 and/or Relay 2 will be held open. If these schedules are set, enabling this option will activate these schedules.

Local Group Programming

This option, when enabled, forces any new users added to the system to be assigned to a group.



Events View the event log stored from the last time the M-PROX2 was online.

Date	Code	Event type
01/01/00 - 00:00:15	5225	Activation relay 2
01/01/00 - 00:00:10	5225	Activation relay 2
01/01/00 - 00:00:10	5225	Code inserted
01/01/00 - 00:00:07	225	Invalid code
15/10/14 - 08:30:00	1	Forced deactivation of relay
15/10/14 - 07:30:00	1	Forced activation of relay
14/10/14 - 18:30:00	1	Forced deactivation of relay
14/10/14 - 17:30:00	1	Forced activation of relay
14/10/14 - 09:14:53	0	Programming parameters
14/10/14 - 08:30:00	1	Forced deactivation of relay
14/10/14 - 07:30:00	1	Forced activation of relay
13/10/14 - 18:30:00	1	Forced deactivation of relay
13/10/14 - 17:30:00	1	Forced activation of relay
13/10/14 - 08:30:00	1	Forced deactivation of relay
13/10/14 - 07:30:00	1	Forced activation of relay
10/10/14 - 18:30:00	1	Forced deactivation of relay
10/10/14 - 17:30:00	1	Forced activation of relay
10/10/14 - 08:30:00	1	Forced deactivation of relay
10/10/14 - 07:36:23	5225	Activation relay 2
10/10/14 - 07:30:00	1	Forced activation of relay
09/10/14 - 18:30:00	1	Forced deactivation of relay
09/10/14 - 17:30:00	1	Forced activation of relay
09/10/14 - 08:30:00	1	Forced deactivation of relay
09/10/14 - 07:30:00	1	Forced activation of relay
08/10/14 - 18:30:00	1	Forced deactivation of relay
08/10/14 - 17:30:00	1	Forced activation of relay
08/10/14 - 09:43:33	97573	Activation relay 1
08/10/14 - 09:43:05	97573	Code inserted
08/10/14 - 09:38:44	5225	Activation relay 2
08/10/14 - 09:38:37	5225	Activation relay 2
08/10/14 - 09:38:32	0	Block of codes entry

N. of events: 1150
From: 08/10/14 - 09:38:32
To: 27/10/14 - 13:32:47



Maintenance Allows you to keep a log of maintenance performed on an installation.

b. Creating Groups

Select Group from the File menu. Press the New icon.

N.	Description	Relay 1	Relay 2	APB	Weekly profile	Holiday profile
71	Manager	Yes	Yes	No	Manager	ManagerHolid
72	Worker	Yes	No	No	Worker	Worker holiday

Enter a description for the Group. The group can be given access to control Relay 1, Relay 2 or both by selecting the appropriate check boxes. Enable Anti-passback if required. Select the Weekly and Holiday profiles applicable to the group.

Group parameters

Description:

Relay 1:

Relay 2:

Anti-passback:

Weekly profile:

Holiday profile:

c. Holiday Dates

Use this dialog to set up Holiday dates like Christmas, Labor Day, Thanksgiving, etc... These are typical annual holidays.

Holiday dates

N.	Description	Date	Recurrent
885	Christmas	25/12/2014	Yes
886	Labor day	01/05/2014	Yes
887	test	14/05/2014	No

d. Creating Profiles

Weekly Profiles are used to setup schedules for access from Monday to Sunday. Select New from the icons. Provide a description for the profile. Set up to 2 'On' times for each day.

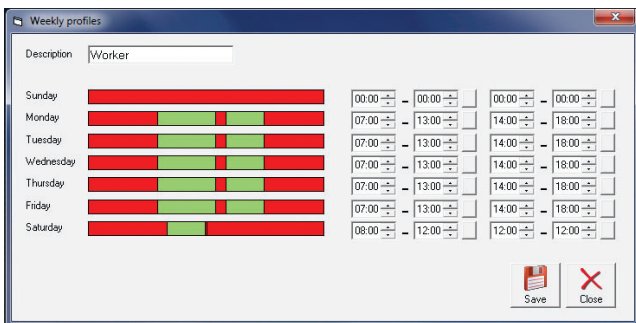
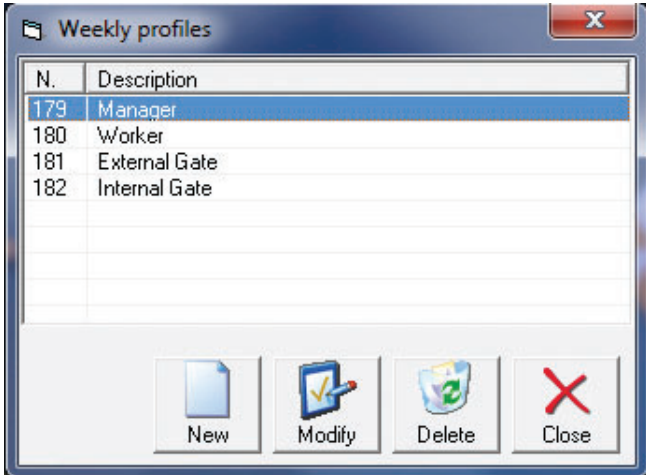

Holiday Profiles are used to setup schedules for access during Holidays as set in the Holiday Dates dialog. These profiles are associated with Group Profiles to determine access schedules during Holidays. Select New from the icons. Provide a description for the profile. Set up to 2 'On' times for each day.

NOTE: The Holiday Profiles supersede the Weekly Profiles.

ii. Hardware

1. Detect Devices

Use this command to detect the **M-PROX2** once it is plugged into the USB port.

iii. Utilities

- 1. ConvertDB v1.3**
- 2. Options**

Language

Set the language for messages and menus.

Serial Port

Select the computer serial port to communicate with the **M-PROX2**.

Database

The "Selected database" box shows which database is used to save installations.

If you want to record the installations on different databases

you must first copy the "pcsys30.mdb" database located in C:\SWManager. Once you have copied and renamed the database, press the "..." button, a window is displayed in which you can select the database to use.

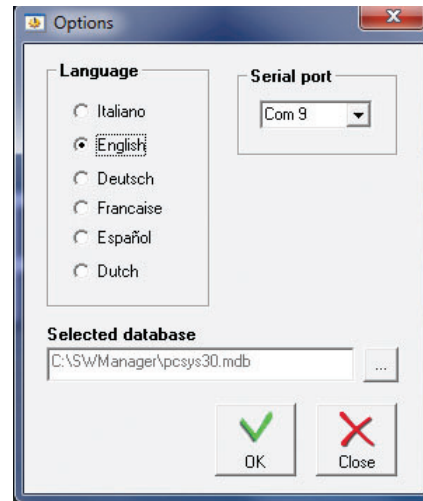

3. Help

This function displays the guide, which can also be recalled by pressing the button "F1" on the keyboard.

4. Information About

b) Working Online

i. Installing the Driver

1. The driver is installed during the installation of the software.

ii. Plugging the M-PROX2 into a USB port

1. Plug the **M-PROX2** supplied USB cable into a spare USB port on the host computer. The computer will automatically detect and install the driver.

iii. Determining the COM Port assigned to the M-Prox2.

1. Open the Computer Control Panel

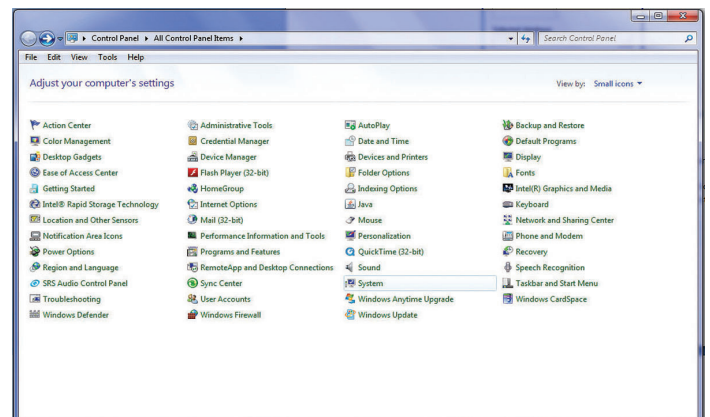

2. Select the System Icon

3. Open the Device Manager

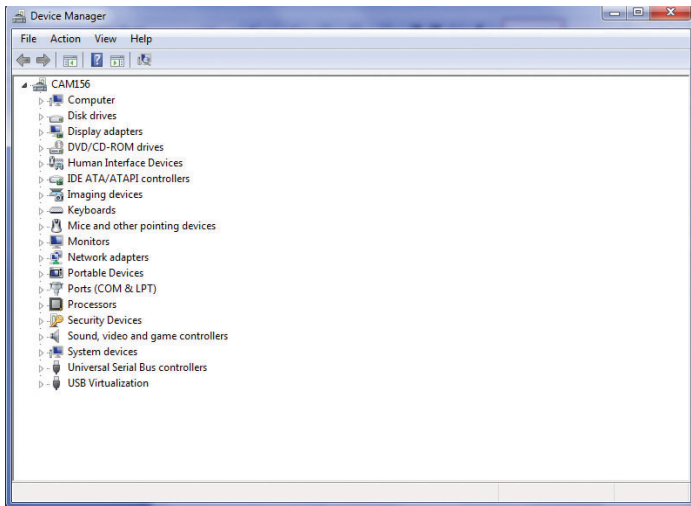

4. Scroll Down to Ports (COM & LPT)

5. Find the entry: USB Serial Port (COMx), where x is the COM port number.

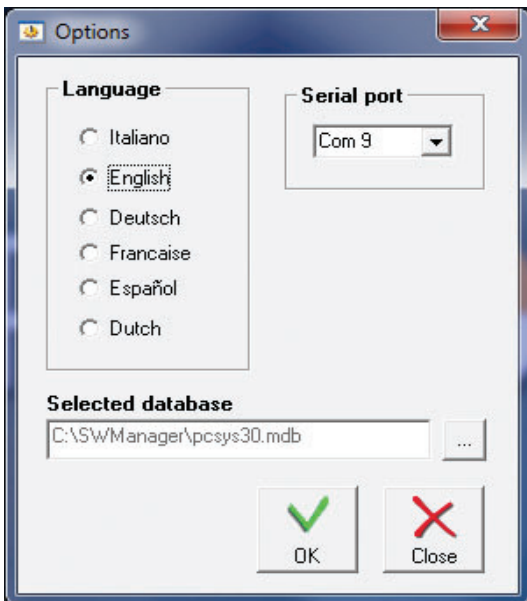

6. Select the correct COM port in the Options screen in the Camden Software Manager.

c) Online Operation

i. Display/Print

Display a list of codes and their parameters stored in the **M-PROX2** memory. Select the Print Icon to print the list to an available printer on the PC.

Address	Code	Copy	Access status	Group	Counter	Start validity	Expiration date
2	1234	0	-	Worker	-	01/05/2014	30/05/2014
3	1236	0	-	Worker	-	01/05/2014	30/05/2014
4	1237	0	-	Worker	-	-	-
5	1238	0	-	Worker	-	-	-
6	1239	0	-	Worker	-	-	-
7	1240	0	-	Worker	-	-	-
8	1241	0	-	Worker	-	-	-
9	1242	0	-	Worker	-	-	-
10	1243	0	-	Worker	-	-	-
11	1244	0	-	Worker	-	-	-
12	1245	0	-	Worker	-	-	-
13	1246	0	-	Worker	-	-	-
14	1247	0	-	Worker	-	-	-
15	1248	0	-	Worker	-	-	-
16	1249	0	-	Worker	-	-	-
17	1250	0	-	Worker	-	-	-
18	1251	0	-	Worker	-	-	-
19	1252	0	-	Worker	-	-	-
20	1253	0	-	Worker	1	-	-
21	233214	0	-	Manager	-	-	-
22	233215	0	-	Manager	-	-	-
23	233216	0	-	Manager	-	-	-
24	233217	0	-	Manager	-	-	-
Total		28					
Memory type		MProx2					
Personalized		<input type="checkbox"/>					
Site Code		0					
Site Extra							

ii. Enter Cards/keytags

Enter proximity cards or keytags individually or in groups. It is important to note that when entering a group of proximity cards or keytags, the Group assigned will be the same for all selected codes.

Number of codes

Enter the total number of codes for the batch you are programming. I.e. for 1 code enter 1, for 10 codes enter 10...etc.

First code

Enter the first code in the batch. If there is only 1 code, enter that code.

Start address

Enter the starting address for the first code to be entered in the **M-PROX2** memory. Valid entries are from 1 to 2000.

Group

Assign to a group the batch of codes you are programming.

Copy

The Copy parameter must be '0' for every new user. Use this field to keep track of lost keytags/cards.

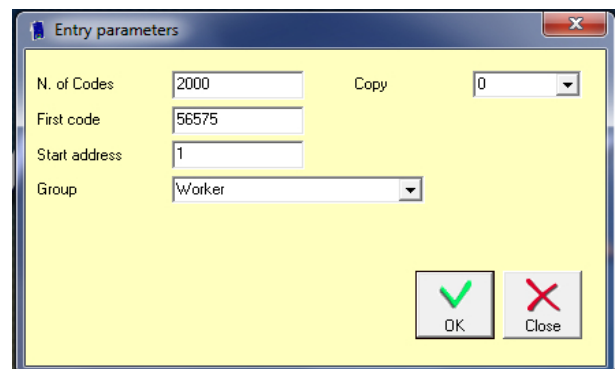

iii. Delete Cards/keyfobs

Deletion – Select

The list of the codes is displayed, from where you can delete one or more of them.

Select the codes to be deleted and confirm with Delete.

If you want to select several consecutive codes, hold the Shift key while you drag the selection with the mouse.

If you want to select non-consecutive codes, select them while holding the Ctrl key.

Deletion - Total

Performs a complete deletion of all the codes in the **M-PROX2**.

iv. Copy

Copy – Module->Database

Reads the contents of the memory module and allows the transfer of the read codes and the eventual personalization into the database.

Press the “New” button to create a new installation in the database and name it then copy the module displayed into the new installation.

Press the “MM->DB” button to copy the module into an installation already present in the database. The list of installations is displayed. Select the installation in which you want to transfer the codes and press “OK”. A message is displayed with the option to overwrite the installation or merge the memory module with the installation.

Copy – Database to module

With this function you can transfer the codes and any personalization of one of the database installations to a memory module.

v. Password

Password – Delete

For deleting the password of a protected memory module.

Password – Enter

The password is a combination of six colored button.

Once you have protected the module with a password, this will be required for each operation of code insertion, code deletion, identifier association or password modification.

vi. Parameters

vii. Events

Events - Download events

Every event present in the **M-PROX2** is downloaded and displayed in a window.

Here you can print the list or save it in the database.

With this operation the events will NOT be erased from the **M-PROX2**.

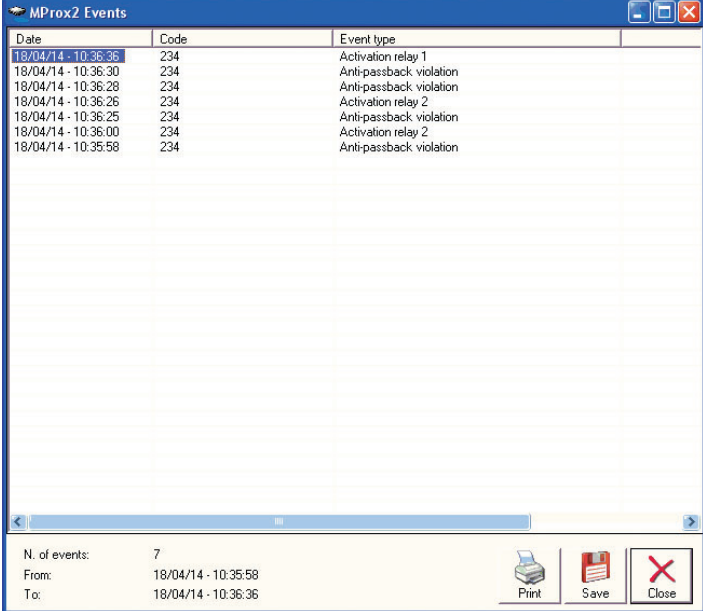

Date	Code	Event type
18/04/14 - 10:36:36	234	Activation relay 1
18/04/14 - 10:36:30	234	Anti-passback violation
18/04/14 - 10:36:28	234	Anti-passback violation
18/04/14 - 10:36:26	234	Activation relay 2
18/04/14 - 10:36:25	234	Anti-passback violation
18/04/14 - 10:36:00	234	Activation relay 2
18/04/14 - 10:35:58	234	Anti-passback violation

N. of events: 7
 From: 18/04/14 - 10:35:58
 To: 18/04/14 - 10:36:36

Print Save Close

Events - Delete events

Delete all events in the device connected.

viii. AntipassBack

Antipassback - Force all to neutral status

Select this option to force the anti-passback status of all users to neutral status.

This can be used in case of a lock/gate malfunction to avoid users being locked inside.

ix. Set Clock

Set the internal **M-PROX2** clock using the PC clock.

e. Access Control

The **M-PROX2** has a number of functions that can be used to define the right of the users.

Every user can be assigned a group authorization which is defined by:

- Relays activation profile
- Anti-pass back activation
- Weekly profile to allow the user to enter only during certain hours of the week
- Holiday profile to allow the user to enter only during certain hours during the holidays

Using SWManager, this can be managed and stored in the database.

Creation of a weekly profile

Select “weekly profile” from the “Files” menu, click on “New” in the profile list

Use arrow or compile field to create the profile for each day of the week in which access can be granted and then add a name to the profile.

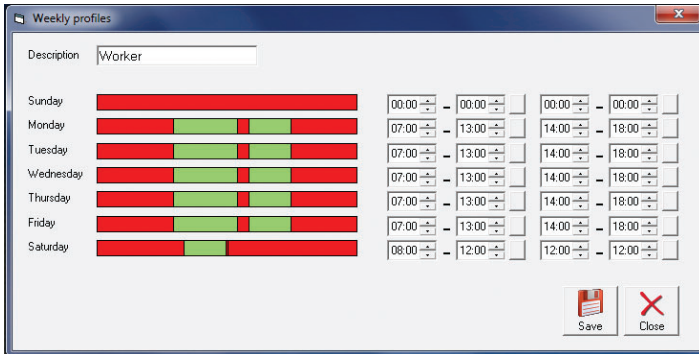

Creation of a holiday profile

Select “Holiday profiles” and “New”

The arrows or the field to create the profile during which access can be granted, and then add a name to the profile.

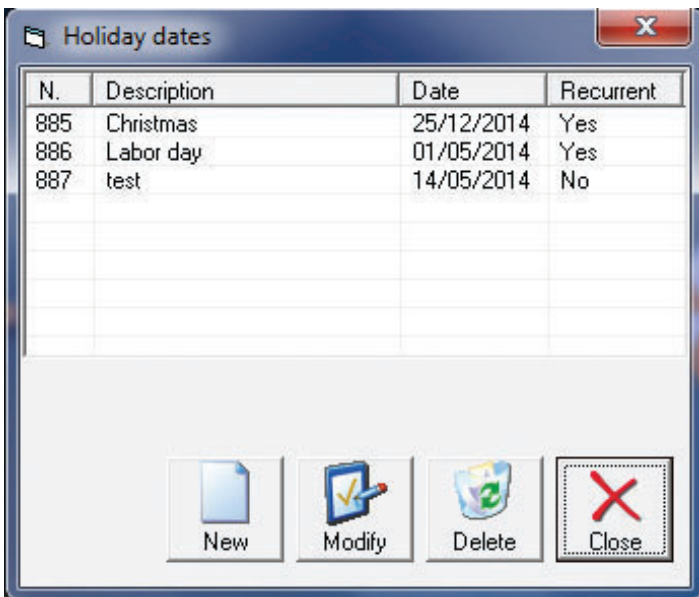

Creation of the holiday dates

Select “Holiday dates” and “New”

Insert the name and the dates of the holiday to be inserted and check “Recurrent” if the Holiday is to be repeated each year.

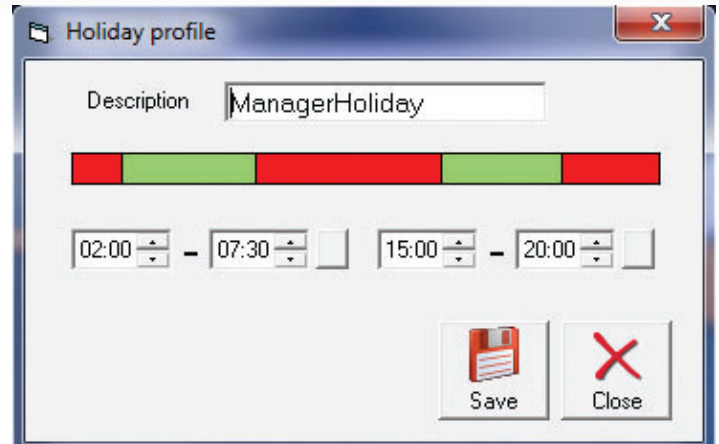

Creation of the group authorization

Each user can be assigned a group authorization which is defined by:

- Relay activation
- Anti-pass back activation
- Weekly profile to allow the user to enter only during certain hours each day of the week
- Holiday profile to allow the user to enter only during certain hours during the holiday

To define the group authorization, select “Groups” from the “Files” menu and then on “New”

Assign a description to the group, and then choose the relay that the user associated to this group can open, the anti-pass back activation, the weekly and holiday profile, and then save.

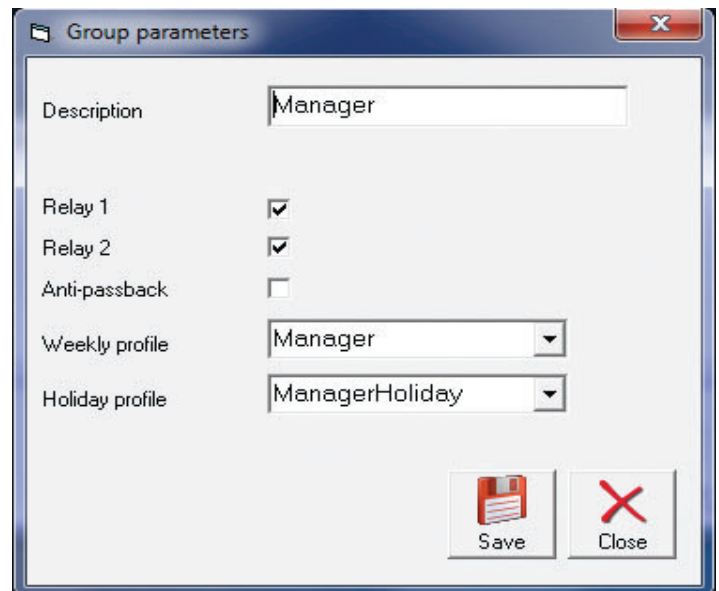

Assign the control access function to the installation

After the creation of the function with the previous entry, you can add them to the installation desired. Select “Installation “ from the “Files” menu and double-click on the desired installation.

To add a group, right-click on the group list in the “Access control functions” and then choose the group to add.

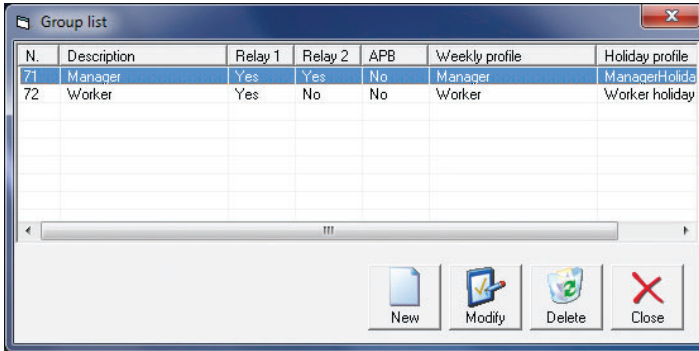

When a group is selected the associated weekly and Holiday profiles are added as well.

To add Holiday dates, right-click on the Holiday dates list in the “Access control functions” and then choose the dates to add.

Relay 1 weekly profile, Relay 2 weekly profile

For each relay of the **M-PROX2**, a weekly profile can be specified. The relay will remain enabled during the hour specified in the corresponding profile. User activation and input REX will open the relay outside the profile.

Appendix A

Interfacing Camden’s CM-120Wv2 Keypad with MProx Door controllers

The CM-120Wv2 keypad can easily replace the proximity reader used with the **M-PROX2** (CV-602) door controller.

The Wiegand protocol output feature of the 120Wv2 keypad is a very simple feature to activate and utilize for use with any basic or enterprise level access control system. When programmed, the keypad will send 26 bit Wiegand protocol numbers to an existing access control system, with or without a facility code (programmable) when a number with a value between 1 and 65,535 is entered into the key pad. Basically, numbers become the credential at this door/entry point, and as long as an individual has been issued a number that is programmed into the access system data base, or enters the numbers from their issued credential (card or FOB) they will be granted access (based on the access group and privilege level associated with their credential)

Once the keypad wiring is complete, as per the diagram below, apply power and begin programming. The programming steps to initiate this feature and associated functions of the feature are listed below.

The CM-120Wv2 keypad has 26 bit Wiegand output capability which is compatible with the **M-PROX2** Wiegand input. Setting up the **M-PROX2** for use with the CM-120Wv2 keypad is easily done:

CM-120Wv2 Setup:

1. Program the CM-120Wv2 keypad for Wiegand output.
2. Program a Site Code (if required) into the CM-120Wv2. (**M-PROX2** CV-602 Only).

Programming the Keypad

In our usual convention, commands contained in square brackets [...] represent keys being pressed together. Always press the * first, then press the secondary key while holding the * down. Release the keys together. All other keys are pressed individually.

- [*1] <master code>(default 1234) * - Enter programming mode
- [*5] 0 # <set Wiegand option> * - Put keypad in Wiegand mode (0= disabled(default), 1=26 bit, 2=26bit+facility code)
- [*5] 1# <set facility code> * - Set facility code if required (Enter facility Code 0-255)

CV-601/602 Setup:

1. Press DEC and INC together to enter programming mode.
2. Use DEC/INC to set the memory location required.
3. On the CM-120Wv2 keypad enter a valid user code and press *.
4. The memory location will have periods inserted after the first 2 numbers. Press Green to accept the programming and periods are inserted after all 4 numbers.
 - a. E.g. Memory 0001 => 000.1. VAL => 0.0.0.1.

Additionally, any of our Wiegand output keypads may be interfaced to the **M-PROX2** units in the same way to replace a proximity reader.

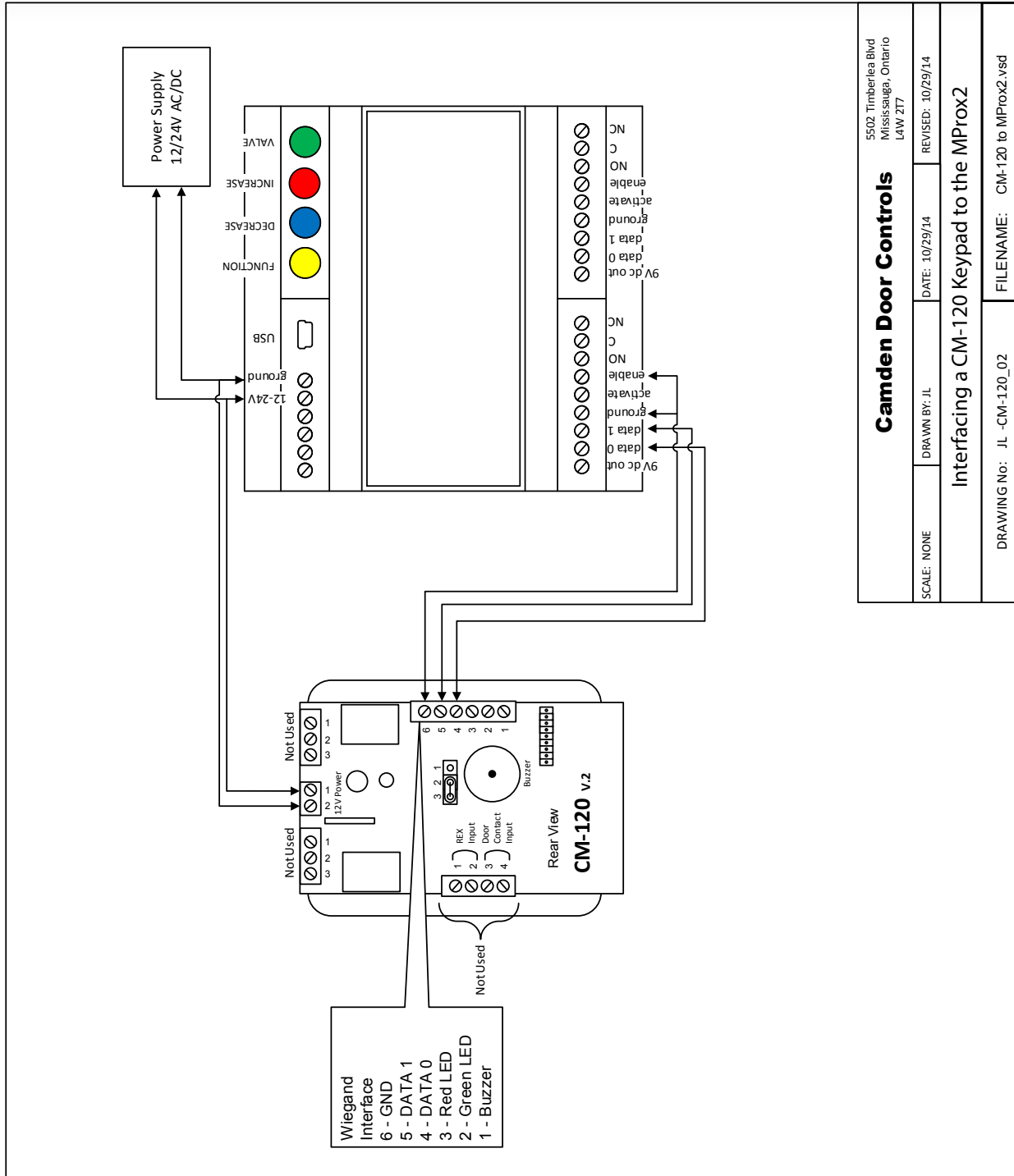

Camden Door Controls		5502 Timberlea Blvd Mississauga, Ontario L4W 2T7	
SCALE: NONE	DRAWN BY: JL	DATE: 10/29/14	REVISED: 10/29/14
Interfacing a CM-120 Keypad to the MProx2			
DRAWING No: JL -CM-120_02		FILENAME: CM-120 to MProx2.vsd	



Push Buttons



Keypads



Strikes



Magnetic Locks



Key Switches



Relays & Timers



Access Control



DISCOVER THE BEST IN DOOR ACTIVATING AND LOCKING PRODUCTS!

www.camdencontrols.com
Toll Free: 1.877.226.3369

File: M-PROX2 Instructions.indd- Rev1
Revised: November 18th, 2014

Part No: 40-82B163